

MVP831 DVD / Video CD / CD Player

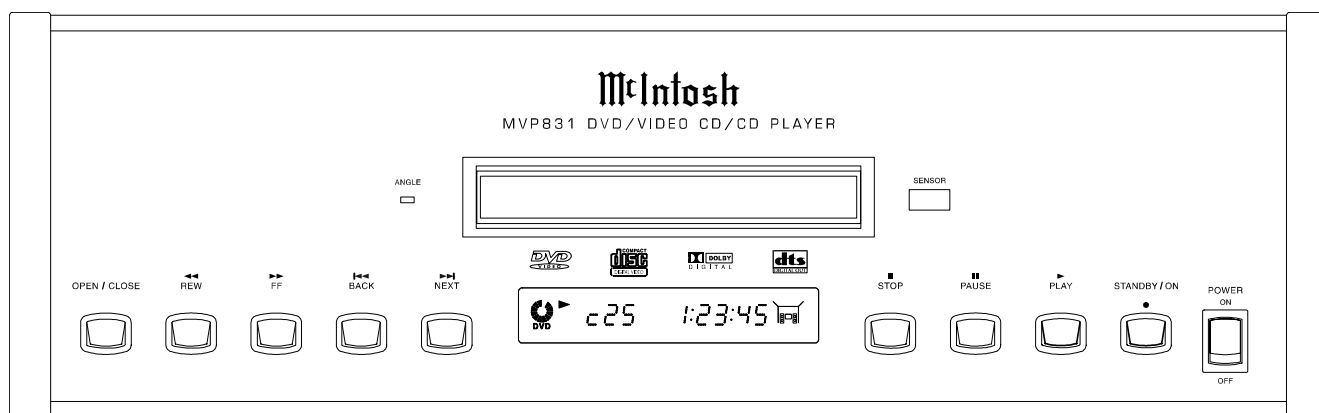

Manufactured under license from Dolby Laboratories, "Dolby", "Pro Logic" and the double-D symbol are registered trademark of Dolby Laboratories.

This product incorporates copyright protection technology that is protected by method claims of certain U.S. Patents and other intellectual property rights owned by Macrovision Corporation and other rights owners. Use of this copyright protection technology must be authorized by Macrovision Corporation, and is intended for home and other limited viewing uses only unless otherwise authorized by Macrovision Corporation. Reverse engineering or disassembly is prohibited.

MVP831

Thank You

Your decision to own this McIntosh MVP831 Video Disc Player ranks you at the very top among discriminating music listeners. You now have "The Best." The McIntosh dedication to "Quality," is assurance that you will receive many years of musical enjoyment from this unit.

Please take a short time to read the information in this manual. We want you to be as familiar as possible with all the features and functions of your new McIntosh.

Please Take A Moment

The serial number, purchase date and McIntosh dealer name are important to you for possible insurance claim or future service. The spaces below have been provided for you to record that information:

Serial Number: _____

Purchase Date: _____

Dealer Name: _____

Technical Assistance

If at any time you have questions about your McIntosh product, contact your McIntosh dealer who is familiar with your McIntosh equipment and any other brands that may be part of your system. If you or your dealer wish additional help concerning a suspected problem, you can receive technical assistance for all McIntosh products at:

McIntosh Laboratory, Inc.
2 Chambers Street
Binghamton, New York 13903
Phone: 607-723-3512
Fax: 607-723-3636

Customer Service

If it is determined that your McIntosh product is in need of repair, you can return it to your dealer. You can also return it to the McIntosh Laboratory Service Repair department. For assistance on factory repair return procedure, contact the McIntosh Repair Department at:

McIntosh Laboratory, Inc.
2 Chambers Street
Binghamton, New York 13903
Phone: 607-723-3515
Fax: 607-723-1917

Copyright 1999 © by McIntosh Laboratory, Inc.

Table of Contents

Thank You	2
Please Take a Moment	2
Technical Assistance	2
Customer Service	2
Table of Contents	2
Safety Instructions	3
Introduction	4
Performance Features	4
Installation	5
Rear Panel Connections and Switch	6
How to Connect the MVP831	7
Front Panel Indicators, Push-Buttons and Switch	8
Front Panel Display	9
Remote Control Push-Buttons	10
How to Operate by Remote Control	11
Setup Mode	12
How to Operate the MVP831	22
Specifications	25
Packing Instruction	27

NOTES:

1. The following Connecting Cable is available from the McIntosh Parts Department:
Data and Power Control Cable Part No. 170-202
Six foot, shielded 2 conductor, with 1/8 inch stereo mini phone plugs on each end.
2. For additional connection information, refer to the owner's manual(s) for any component(s) connected to the MVP831 Video Disc Player.
3. The MVP831 has a built-in 96kHz DAC (Digital Audio Converter) to allow playing of DVD's recorded with a higher bit rate by using the Analog Audio Outputs.
4. Several of the DVD performance features available on the MVP831 are active only if the DVD includes the supporting encoded information.
5. The translucent Remote Control pushbuttons, except for the Setup pushbutton, will illuminate for approximately 3 seconds when activated.
6. When AC power is turned off, the MVP831 front panel nomenclature will remain On for a few seconds.
7. In the unlikely event you are unable to remove a disc from the player, there is a built-in tray release lever. Using a suitable size screwdriver, move the Tray Release lever from the Normal to the Release position. The tray will move out just far enough to grasp it and pull it open. After removing the disc, press the tray fully back into the player.

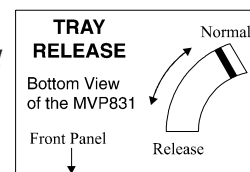

IMPORTANT SAFETY INSTRUCTIONS!

PLEASE READ THEM BEFORE OPERATING THIS EQUIPMENT.



WARNING SHOCK HAZARD - DO NOT OPEN.

The lightning flash with arrowhead, within an equilateral triangle, is intended to alert the user to the presence of uninsulated "dangerous voltage" within the product's enclosure that may be of sufficient magnitude to constitute a risk of electric shock to persons.



AVIS RISQUE DE CHOC - NE PAS OUVRIR.

The exclamation point within an equilateral triangle is intended to alert the user to the presence of important operating and maintenance (servicing) instructions in the literature accompanying the appliance.

CAUTION
RISK OF ELECTRIC SHOCK
DO NOT OPEN

ATTENTION
DANGER D'ELECTROCUTION
NE PAS OUVRIR

NO USER-SERVICEABLE PARTS INSIDE. REFER SERVICING TO QUALIFIED PERSONNEL

To prevent the risk of electric shock, do not remove cover (or back). No user serviceable parts inside. Refer servicing to qualified personnel.

General:

1. Read all the safety and operating instructions, contained in this owner's manual, before operating this equipment.
2. Retain this owner's manual for future reference about safety and operating instructions.
3. Adhere to all warnings and operating instructions.
4. Follow all operating and use instructions.
5. **Warning: To reduce risk of fire or electrical shock, do not expose this equipment to rain or moisture. This unit is capable of producing high sound pressure levels. Continued exposure to high sound pressure levels can cause permanent hearing impairment or loss. User caution is advised and ear protection is recommended when playing at high volumes.**
6. **Caution: to prevent electrical shock do not use this (polarized) plug with an extension cord, receptacle or other outlet unless the blades can be fully inserted to prevent blade exposure.**

Attention: pour prevenir les chocs electriques pas utiliser cette fiche polarisee avec un prolongateur, une prise de courant ou un autre sortie de courant, sauf si les lames peuvent etre inserees afond ans en laisser aucune partie a decouvert.

7. For added protection for this product during a lightning storm, or when it is left unattended and unused for long periods of time, unplug it from the wall outlet. This will prevent damage to the product due to lightning or power line surges.
8. Do not use attachments not recommended in this owner's manual as they may cause hazards.

Installation:

9. Locate the equipment for proper ventilation. For example, the equipment should not be placed on a bed, sofa, rug, or similar surface that may block ventilation openings; or placed in a built-in installation, such as a bookcase or cabinet, that may impede the flow of air through the ventilation openings.
10. Locate the equipment away from heat sources such as radiators, heat registers, stoves, or other appliance (including amplifiers) that produce heat.
11. Mount the equipment in a wall or cabinet only as described in this owner's manual.
12. Do not use this equipment near water; for example, near a bathtub, washbowl, kitchen sink, laundry tub, in a wet basement or near a swimming pool, etc.
13. Do not place this product on an unstable cart, stand, tripod, bracket, or table. The equipment may fall, causing serious injury to a person, and serious damage to the product.

Connection:

14. Connect this equipment only to the type of AC power source as marked on the unit.
15. Route AC power cords so that they are not likely to be walked on or pinched by items placed upon or against them, paying particular attention to cords at plugs, convenience receptacles, and the point where they exit from the instrument.
16. Do not defeat the inherent design features of the polarized plug. Non-polarized line cord adapters will defeat the safety provided by the polarized AC plug. If the plug should fail to fit, contact your electrician to replace your obsolete outlet. Do not defeat the safety purpose of the grounding-type plug.

17. Do not overload wall outlets, extension cords or integral convenience receptacles as this can result in a risk of fire or electric shock.

Care of Equipment:

18. Clean the instrument by dusting with a dry cloth. Unplug this equipment from the wall outlet and clean the panel with a cloth moistened with a window cleaner. Do not use liquid cleaners or aerosol cleaners.
19. Do not permit objects of any kind to be pushed and/or fall into the equipment through enclosure openings. Never spill liquids into the equipment through enclosure openings.
20. Unplug the power cord from the AC power outlet when left unused for a long period of time.

Repair of Equipment:

21. Unplug this equipment from the wall outlet and refer servicing to a qualified service personnel under the following conditions:
 - A. The AC power cord or the plug has been damaged.
 - B. Objects have fallen, or liquid has been spilled into the equipment.
 - C. The equipment has been exposed to rain or water.
 - D. The equipment does not operate normally by following the operating instructions contained within this owner's manual. Adjust only those controls that are covered by the operating instructions, as an improper adjustment of other controls may result in damage and will often require extensive work by a qualified technician to restore the product to its normal operation.
 - E. The equipment has been dropped or damaged in any way.
 - F. The equipment exhibits a distinct change in performance - this indicates a need for service.
22. Do not attempt to service beyond that described in the operating instructions. All other service should be referred to qualified service personnel.
23. When replacement parts are required, be sure the service technician has used replacement parts specified by McIntosh or have the same characteristics as the original part. Unauthorized substitutions may result in fire, electric shock, or other hazards.
24. Upon completion of any service or repairs to this product, ask the service technician to perform safety checks to determine that the product is in proper operating condition.

Introduction

The McIntosh MVP831 DVD/Video CD/CD Player offers the latest in audio/video technology to provide state of the art reproduction of digital video and audio program sources. A full complement of performance features gives you the opportunity to enjoy all the special audio and video formats available on a DVD. Audio CD's are also reproduced with flawless realism. The advanced mechanical design of the transport ensures many years of smooth trouble free operation.

Performance Features

● Dual-Focus Hologram Laser Lens

The MVP831 incorporates a dual-focus hologram lens that splits the beam of the already super-fine laser so it can read two disc layers simultaneously. This unique design eliminates the need for two separate laser systems and ensures full compatibility with your existing CD library. The unique MVP831 Red Laser has a thinner beam with a shorter wavelength to more accurately read the densely-packed 4.7 gigabytes of information on a single layer of a DVD disc.

● Advanced Transport

The MVP831 transport has side suspension dampers for improved trackability and lower bit error rate. Also included is a new hydrodynamic bearing spindle motor. These mechanical innovations ensure greater stability for playback even with high sound pressure levels in the home theater room.

● Advanced Video DAC

An advanced technology 10-Bit DAC (Digital Analog Converter) performs video signal processing at a faster rate than ever for enhanced DVD picture quality. A DVD can generate pictures in amazing detail, thanks to 500 lines of horizontal resolution capability, which is more than twice that of VHS video tapes.

● 96kHz 24 BIT Burr Brown Audio DAC

The MVP831 built-in Burr Brown 96kHz 24 Bit Digital to Analog Converter ensures future compatibility with the higher rate audio formats.

Installation

The MVP831 can be placed upright on a table or shelf, standing on its four feet. It also can be custom installed in a piece of furniture or cabinet of your choice. The required panel cutout, ventilation cutout and unit dimensions are shown.

Always provide adequate ventilation for your MVP831. Cool operation ensures the longest possible operating life for any electronic instrument. Do not install the MVP831 directly above a heat generating component such as a high powered amplifier. If all the components are installed in a single cabinet, a quiet running ventilation fan can be a defi-

nite asset in maintaining all the system components at the coolest possible operating temperature.

A custom cabinet installation should provide the following minimum spacing dimensions for cool operation. Allow at least 2 inches (5.1cm) above the unit and 1 inch (2.54cm) on each side of the control center, so that airflow is not obstructed. Allow 16 inches (40.64cm) depth behind the mounting panel, which includes clearance for connectors. Allow 3/4 inch (1.9cm) in front of the mounting panel for clearance. Be sure to cut out a ventilation hole in the mounting shelf according to the dimensions in the drawing.

Front View of the MVP831 custom installed

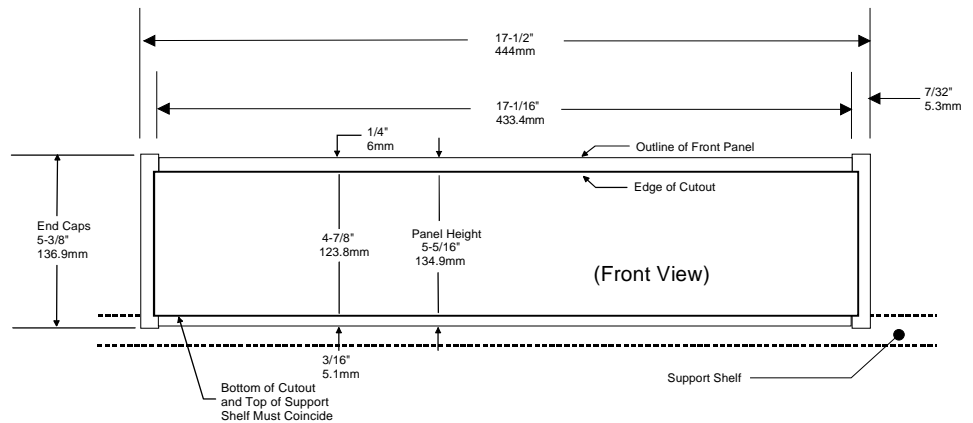

Side View of the MVP831 custom installed

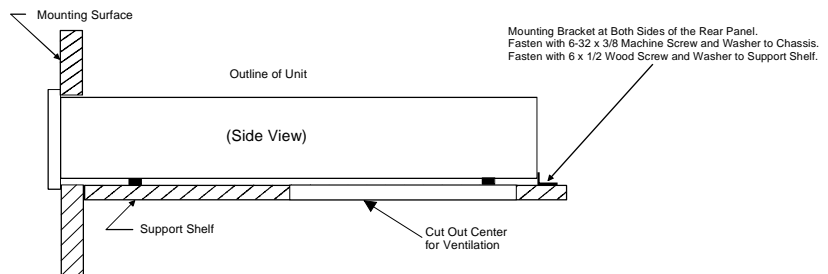

Bottom View of the MVP831 custom installed

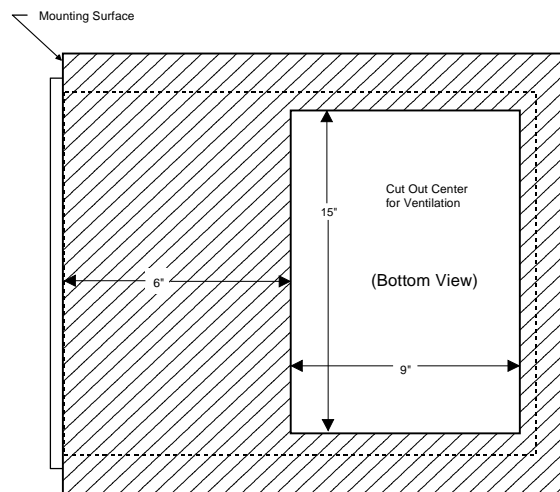

MVP831 Rear Panel Connections

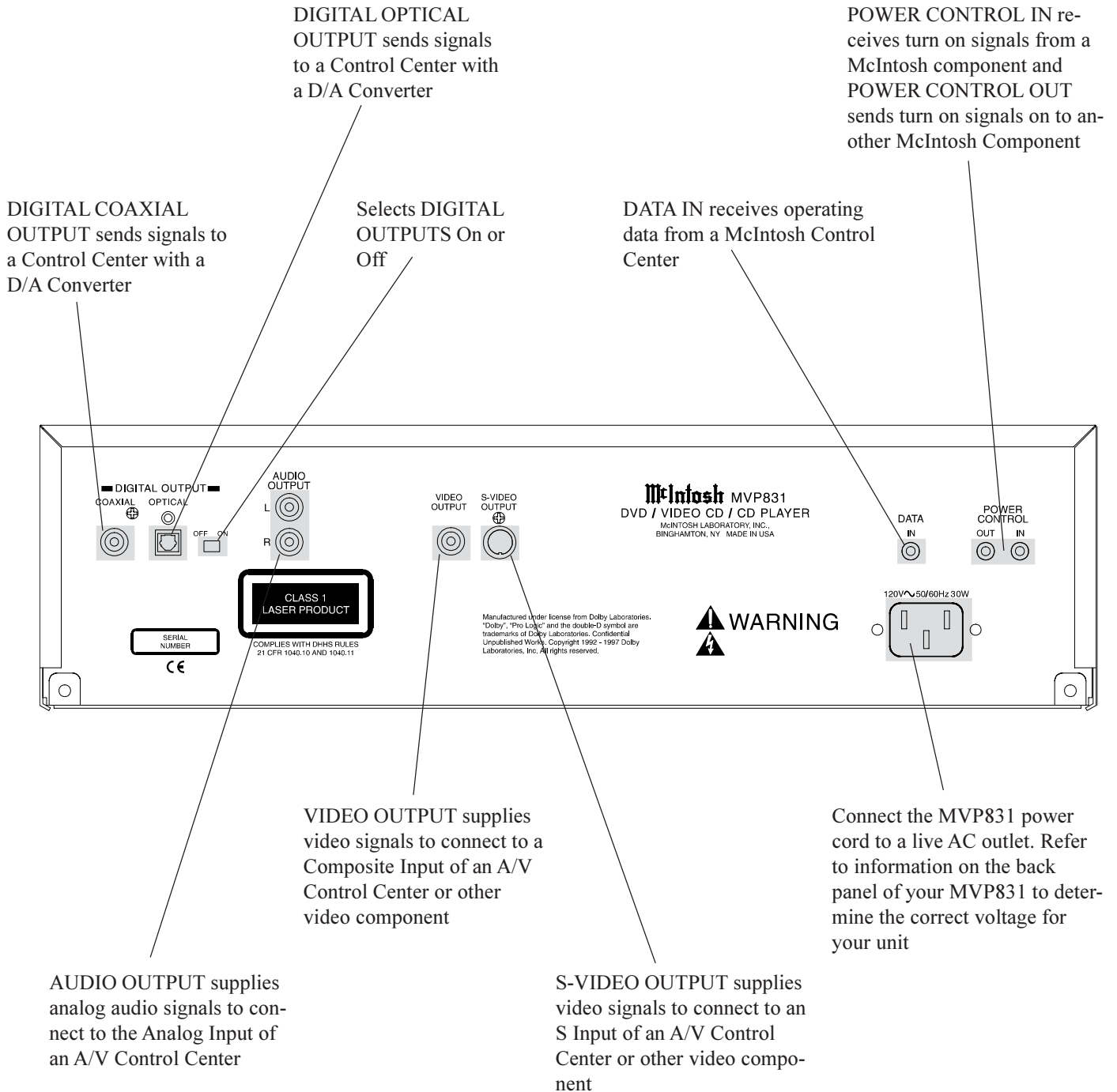

How to Connect the MVP831

1. Connect the MVP831 power cord to a live AC outlet.
 2. Connect a Power Control Cable from the MVP831 POWER CONTROL IN to the POWER CONTROL A Output jack of a McIntosh MX132 A/V Control Center.
 3. Connect a Data Cable from the MVP831 DATA IN jack to the DVD DATA (11) jack on the McIntosh MX132 A/V Control Center.
 4. Connect a Coaxial Cable from the MVP831 COAXIAL DIGITAL OUT to the DVD COAXIAL DIGITAL INPUT of a McIntosh MX132 A/V Control Center.
- Note: An optional connecting method is to use an optical cable from the MVP831 OPTICAL DIGITAL OUTPUT to the Optical Digital Input of a McIntosh MX132 A/V Control Center.*
5. Connect an "S" Video Cable from the MVP831 S-VIDEO OUTPUT to the DVD "S" VIDEO INPUT on a McIntosh MX132 A/V Control Center.

6. Connect a video cable from the MVP831 Composite VIDEO OUTPUT to the CR12 V-AUX Video Input. Connect a video cable from the CR12 V-AUX VIDEO OUTPUT to the MX132 DVD Composite DVD VIDEO INPUT.

Note: If a McIntosh CR12 is not used then connect MVP831 Composite VIDEO OUTPUT to the MX132 DVD Composite DVD VIDEO INPUT.

7. Connect Audio Cables from the MVP831 L and R AUDIO OUTPUTS to the DVD ANALOG AUDIO INPUTS on a McIntosh MX132 A/V Control Center.

Optional Connecting Information

If the MVP831 is connected in a system consisting of a McIntosh C39 or MX130 Control Center together with a CR12 Multizone Controller, then the following two additional connections need to be made.

1. Connect Data cables, using Y connectors, from the MVP831 DATA IN to the CR12 VAUX DATA IN and the C39/MX130 V-AUX DATA PORT.
2. Connect cables, using Y connectors, from the MVP831 Analog AUDIO OUTPUTS to the C39/MX130 V-AUX Audio Inputs and the CR12 V-AUX Audio Inputs.

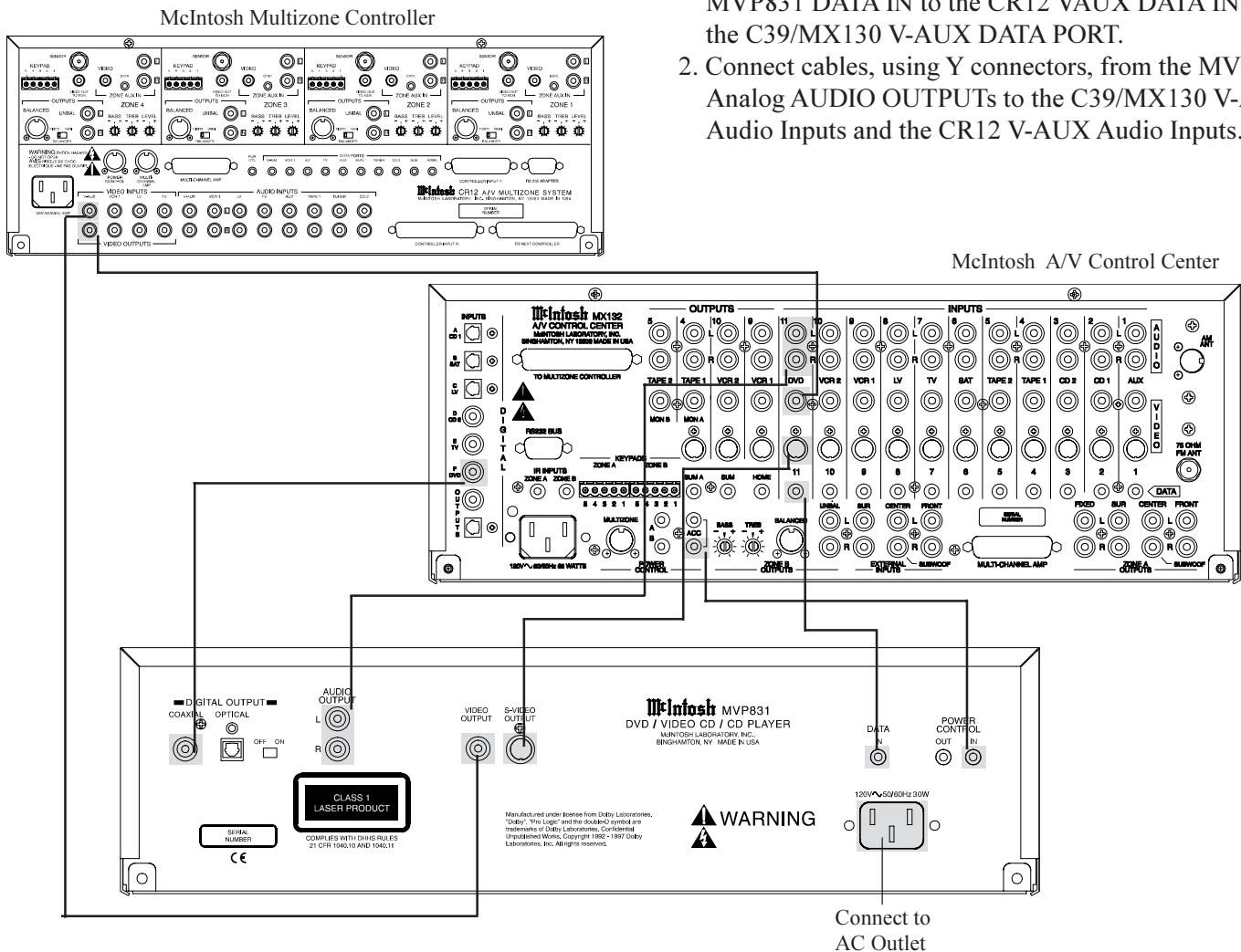

MVP831 Front Panel Indicators, Push-Buttons and Switch

Opens and Closes the disc tray for loading or unloading discs

Disc Tray opens to load and unload a disc

Standby Power On Indicator

Angle On Indicator

IR Sensor receives commands from a remote control

POWER switch turns all AC power completely ON or OFF

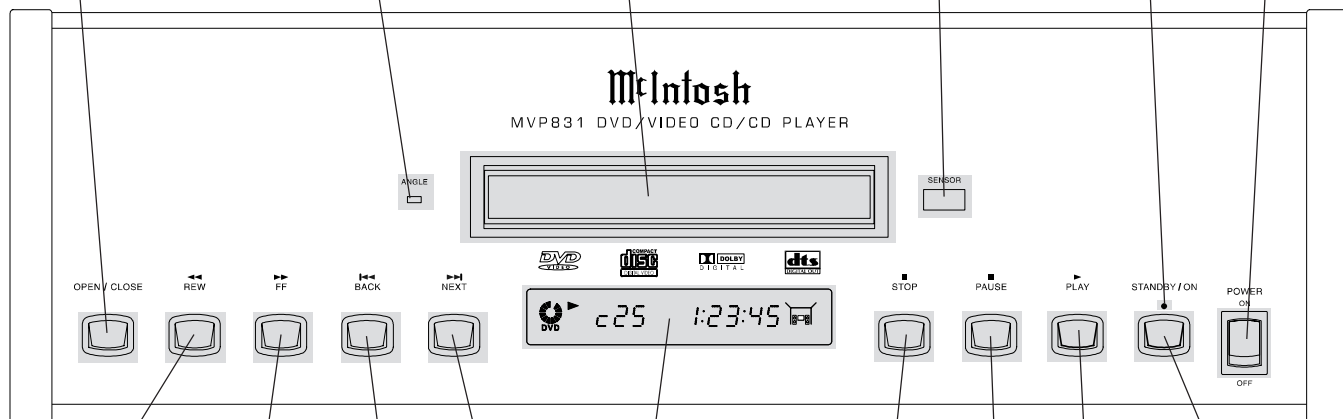

Move rapidly backward through a disc during play

Move back one track or chapter at a time

Front Panel Display

Use to pause during play

STANDBY/ON push-button turns the MVP831 ON or OFF (Standby)

Move rapidly forward through a disc during play

Move forward one track or chapter at a time

Stops disc play

Starts disc play

MVP831 Front Panel Display

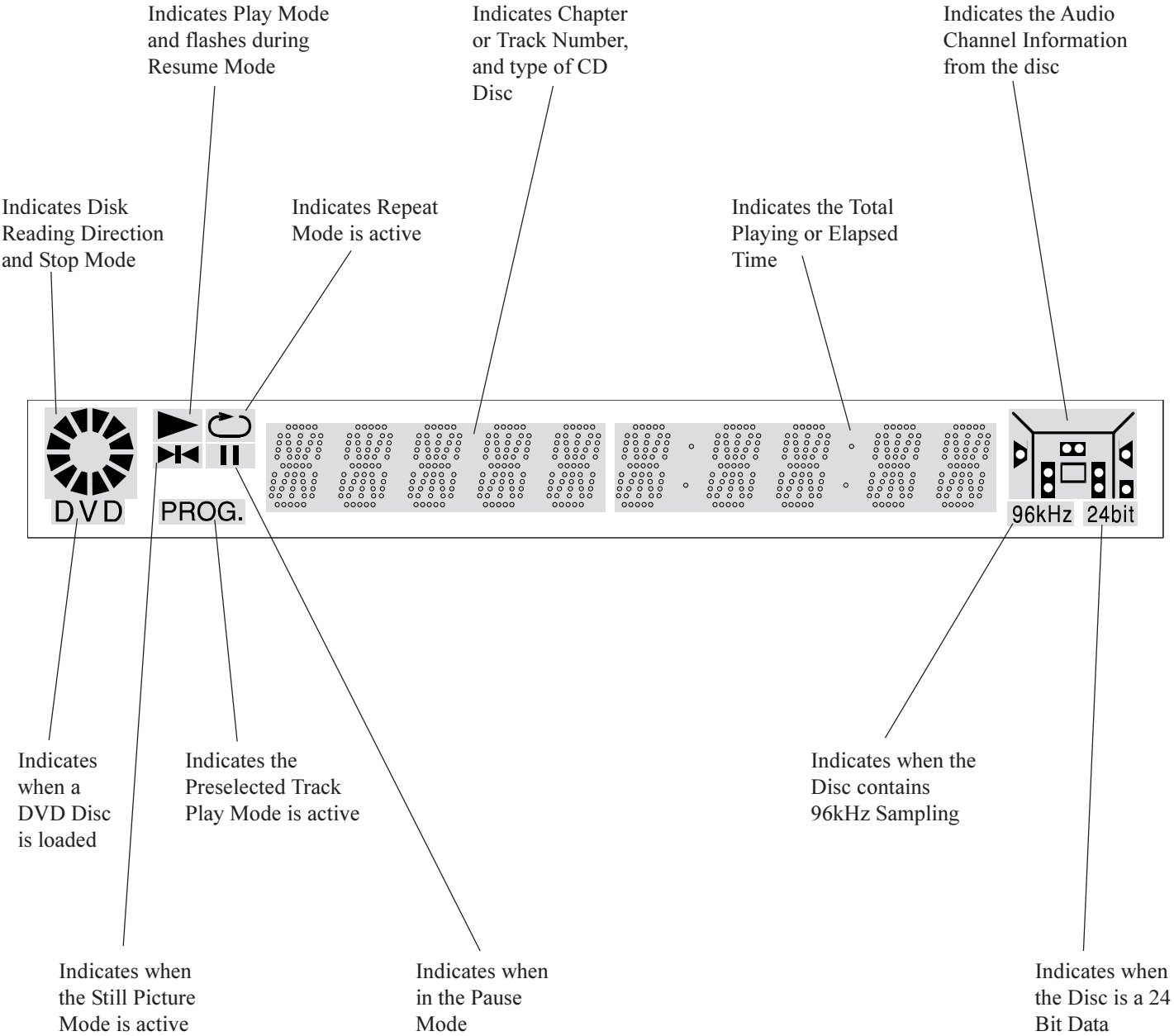

Remote Control Push-Buttons

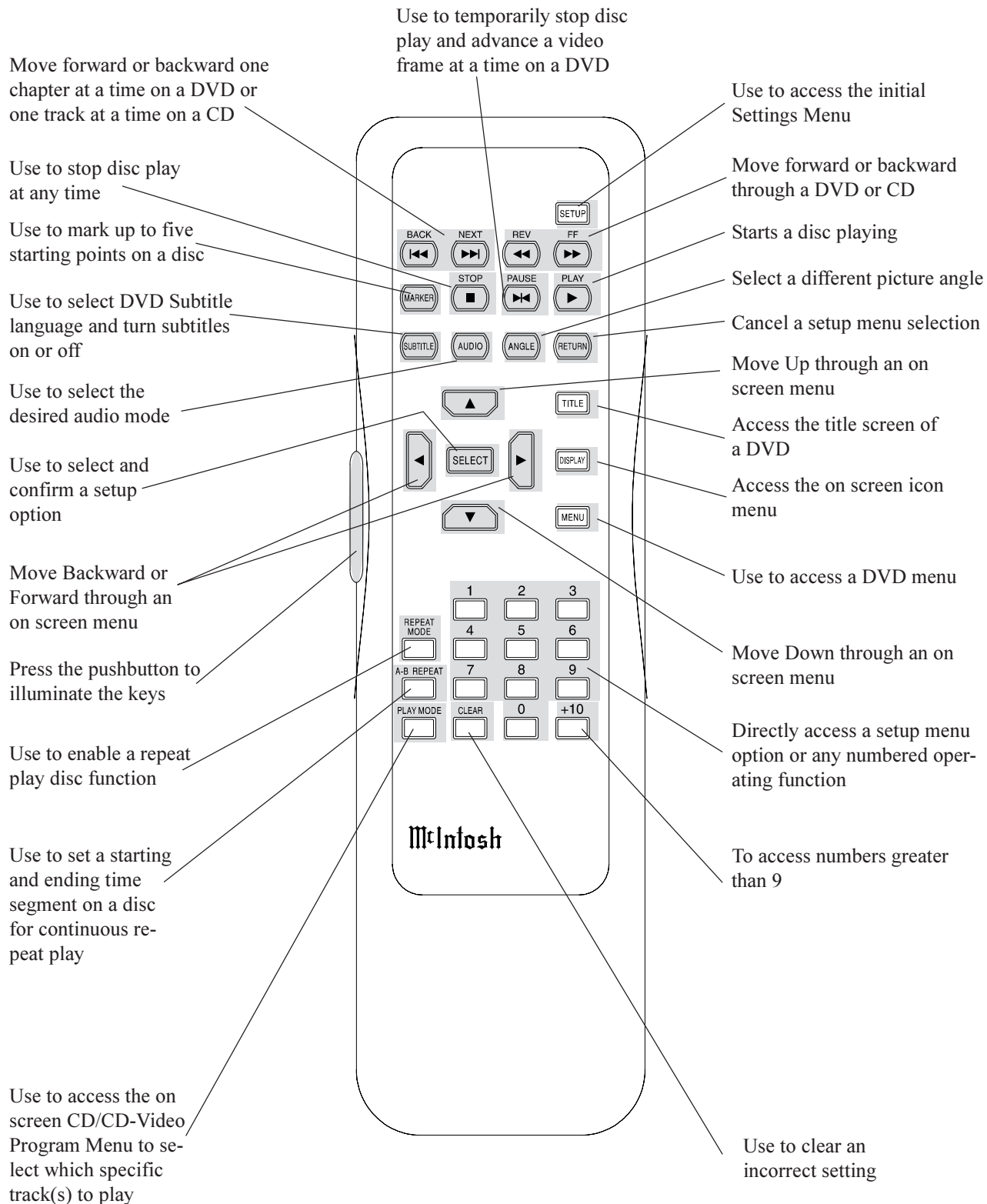

How to Operate the Remote Control

The Remote Control is capable of performing both basic operating functions and setup options. Refer to the How to Operate and How to Setup Sections of this manual for more detailed information on how to use the Remote Control to customize certain setup and operating functions for your individual requirements.

Play

With a disc loaded press the PLAY pushbutton to start the disc playing.

Stop

Press the STOP pushbutton to stop disc play at any time. Press PLAY and the disc will start playing again from the disc time where STOP was pressed. Press STOP twice to return to the beginning of a disc.

Numbered and +10 Pushbuttons

Use to directly access a Setup Menu option.

For DVD's - Press combinations of 1 through 9 to directly access DVD Chapters using the On Screen Icon. For example to access Chapter 23, press 2, 3 and then SELECT. Press 1 through 9 to access CD tracks.

Note: This function requires that you first press the DISPLAY pushbutton to access the On Screen Icon.

For CD's - Press the +10 pushbutton first and then required number. For example to access Track 23, press +10 and then 23.

Clear

Press the CLEAR pushbutton to erase a selected track or incorrect setting.

Pause

Press the PAUSE pushbutton to temporarily stop play operation at any time on a DVD or CD. When a DVD is playing, each time the PAUSE pushbutton is pressed again, the player will jump to the next video frame.

Back and Next

Press either of these pushbuttons to move forward or backward one chapter at a time on a DVD or one track at a time on a CD.

Return

Press the RETURN pushbutton to cancel a setup menu selection.

Setup

Press the SETUP pushbutton to access the Initial Setup Menu.

Subtitle

Press the SUBTITLE pushbutton to access the Subtitle menu and the Subtitle icon will appear at the top of the screen.

Marker

While a disc is playing, use MARKER pushbutton to establish in memory up to five different starting points on a disc where you wish play to start other than at the beginning.

Angle

If the DVD being played supports the Angle feature, press the ANGLE pushbutton to select the desired video picture angle.

Four Direction Arrows

Press an Arrow direction pushbutton to move backward, forward, up or down through an on screen menu.

Select

Press the SELECT pushbutton to confirm and activate a setup option or options indicated by the on screen icons.

Title

When a disc is loaded in the player, press the TITLE pushbutton to access the DVD Title menu.

Display

Press the DISPLAY pushbutton to access the on screen options icons.

Audio

Press the AUDIO pushbutton to access the sound track format you wish to activate.

REV and FF

Press a REV (Reverse) or FF (Fast Forward) pushbutton to start moving rapidly through a chapter or track on a disc.

Note: Audio level is automatically reduced during this operating mode.

A-B Repeat

This feature allows a selected segment of a disc to be repeated continuously.

How to Operate the Setup Mode

Your McIntosh MVP831 has been factory configured for default operating settings that will allow you to immediately enjoy superb video and high fidelity audio from a DVD and also reproduce CDs with unparalleled sonic purity. If you wish to make changes to the factory default settings, a Setup feature is provided to customize the operating settings using On Screen Menus.

Note: The MVP831 must be connected to an A/V Control Center and a MONITOR/TV for setup and use. If a disc is loaded, the player must be in STOP mode before setup can occur.

1. Press the POWER switch to ON. The Red LED above the STANDBY/ON switch lights to indicate the MVP831 is in Standby mode. To turn ON the MVP831, press the STANDBY/ON push-button. Refer to figure 1.
2. Press the SETUP pushbutton on the Remote Control and the Initial Setup Menu will appear on the Monitor/TV screen. Most menu choices can be directly accessed by pressing the appropriate number pushbutton on the Remote Control. Other choices may require pressing one or more Arrow pushbuttons and then the Select pushbutton. Refer to figures 2 & 3.

Note: Some menu choices require more than one step to complete.

3. Access the desired Setup Menu by pressing the appropriate number pushbutton on the MVP831 Remote Control. The desired Setup Menu will then appear on the MONITOR/TV screen for further action. Follow the instructions for each of the desired setup menus.
4. After all setup adjustments are complete, press pushbutton Number 0 to exit the Initial Setup Menu.

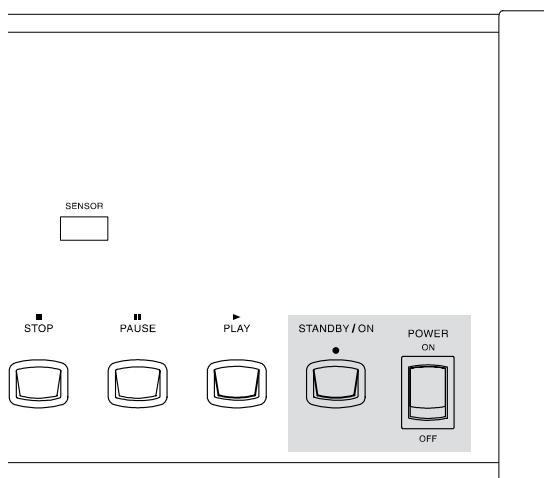

Figure 1

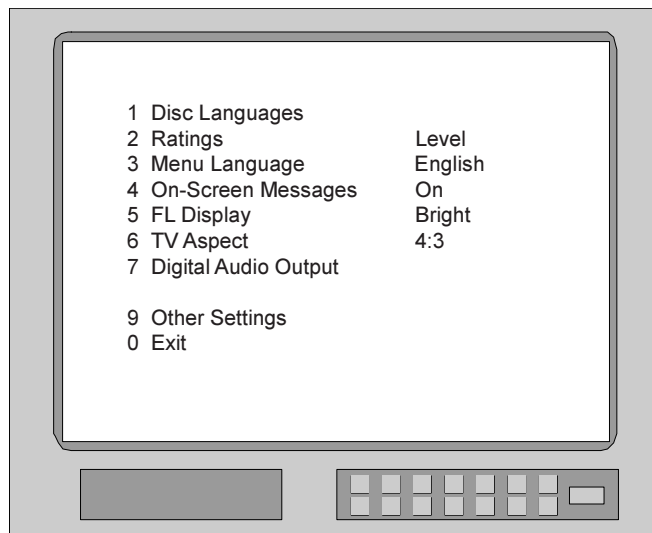

Figure 2

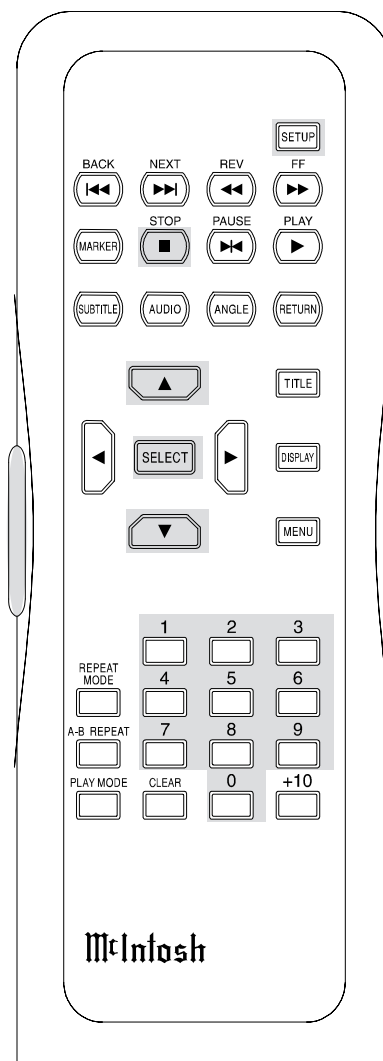

Figure 3

Default Settings

The following listings indicate the factory default settings. Refer to the listed page number for instructions on how to change a default setting.

Language Settings:

<u>Name</u>	<u>Selection</u>	<u>Refer to Page</u>
Audio	English	13
Menu	English	13
On Screen	English	16
Subtitle English 14		

Ratings Levels:

<u>Name</u>	<u>Selection</u>	<u>Refer to Page</u>
Limit	Level 8 (no limit)	15
Lock Mode	Unlock	15
Password	None	16

Digital Audio Output:

<u>Name</u>	<u>Selection</u>	<u>Refer to Page</u>
LPCM (DVD)	Off	19
Dolby Digital	Bitstream	19
DTS	Off	19

On Screen Settings:

<u>Name</u>	<u>Selection</u>	<u>Refer to Page</u>
Messages	On	17
TV Aspect (ratio)	4:3	18
Subtitle	Automatic	14

Other Settings:

<u>Name</u>	<u>Selection</u>	<u>Refer to Page</u>
Display Brightness	Bright	17
Still Mode	Automatic	20
Audio During Search	On	20
TV Model (4:3)	Pan&Scan	20
D. Range Compression ..	Off	21

How to Set Disc Language

This is to select the soundtrack language, subtitle language and the language used in title menus or DVD menus, which will always be used for every disc to be played.

Note: If a disc is loaded, the player must be in STOP mode before any SETUP operation can occur.

1. Press the SETUP pushbutton to access the Initial Setup Menu. Refer to Figures 2 & 3.
2. Press pushbutton Number 1 to access the Disc Languages Menu and three Submenu choices will appear. Refer to Figure 4.

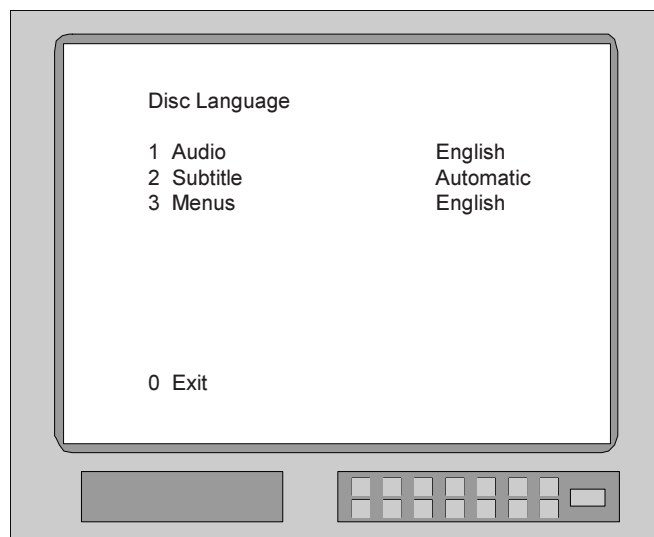

Figure 4

Audio Language

The first submenu choice is the audio language. The Display will indicate English, which is the factory default setting. Refer to Figure 5.



Figure 5

If you wish to change the audio language, press 1 again to access the audio language choice submenu.

Press 1 to select English.

Press 2 to select French.

Press 3 to select Spanish.

Press 4 to select the original language of the disc (factory default language).

Press 5 to select another language code.

Press the CLEAR Pushbutton if you have made an incorrect choice and wish to change the selection.

When an audio language is selected, the Disc Languages menu will reappear.

Subtitle

The second submenu choice is Subtitle. The Subtitle Display will indicate Automatic, which is the Factory Default setting. Subtitles will appear in the language selected in the previous Audio Language choice menu. Refer to Figure 6.

Note: In the Automatic mode, Subtitles can be turned off for any disc that is being played. If instead of Automatic, a specific Subtitle Language is selected, the Subtitle will appear every time, but can be turned off only while that specific disc is played.

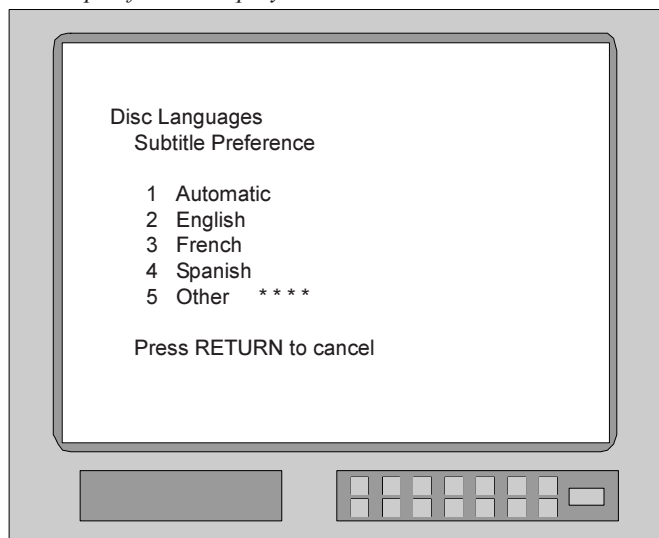

Figure 6

If you wish to change the Subtitle Language, press 2 to access the subtitle submenu.

Press 1 to select Automatic.

Press 2 to select English Subtitles.

Press 3 to select French Subtitles.

Press 4 to select Spanish Subtitles.

Press 5 to select another language for Subtitles.

When a Subtitle option is selected, the Disc Languages menu will reappear.

On Screen Menu Language

The third submenu choice is On Screen Menu Language. English will be indicated which is the factory default setting. Refer to Figure 7

Note: This feature will function only if the required menu language is encoded on the disc.

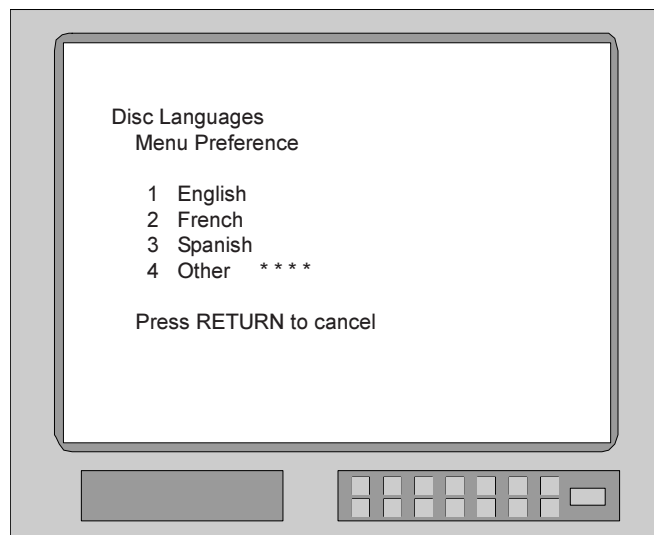

Figure 7

If you wish to change the On Screen Menu Language, press 3 to access the Menu Language submenu.

Press 1 to select English.

Press 2 to select French.

Press 3 to select Spanish.

Press 4 to select another language.

When a Menu language is selected, the Disc Languages menu will reappear.

Press pushbutton Number 0 to exit back to the initial setup menu.

After all setup adjustments are complete, press pushbutton Number 0 to exit the Initial Setup Menu.

How to Set Ratings

Most movies made in recent years have ratings to indicate whether they are suitable for children to view. Some DVD Movie discs have encoded rating levels that allow you to set your MVP831 to prevent your children from viewing inappropriate movies in your absence. A password protected lock function, set by you, sets the rating limit for disc play.

Note: If a disc is loaded, the player must be in STOP mode before any SETUP operation can occur.

1. Press the SETUP pushbutton to access the Initial Setup Menu. Refer to Figures 2 & 3.
2. Press pushbutton Number 2 to access the Ratings Menu. Rating Level "8" allows you to view all DVD movies, regardless of their level rating. Level "0 Lock All" prevents any disc from being viewed. Refer to Figure 8.

Example: A DVD movie rated PG13 normally will be encoded with a Level 3 rating, however, this rating may not be the same for different movie studios. The player password protected level rating must be set to Level Number 3 or lower to prevent this disc from being viewed unless the password is used to unlock the player.

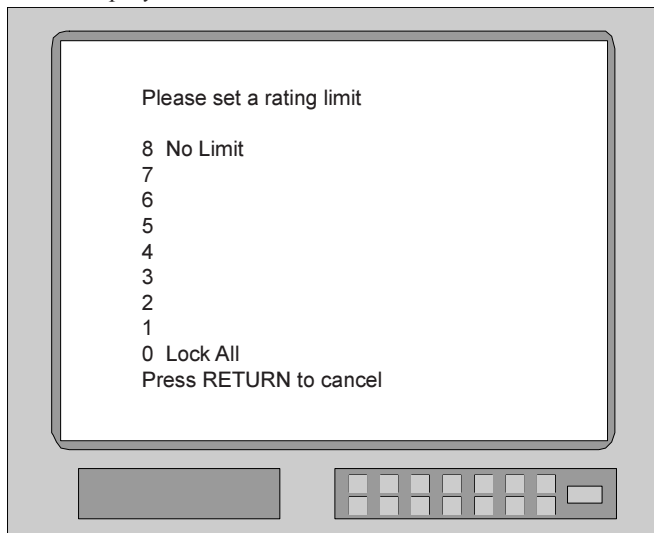

Figure 8

3. Press a Number pushbutton to select the desired ratings level. The Ratings Submenu requesting a password will appear. Refer to Figure 9.

CAUTION: *Be absolutely sure to remember or write down the password number and put it in a safe location for future reference. Once the password has been entered, the player is locked to that ratings limit*

and you will not be able to view a DVD Movie with a rating number at or below the selected rating limit number. If you are unable to find or remember the password, please contact your dealer or McIntosh Technical Support.

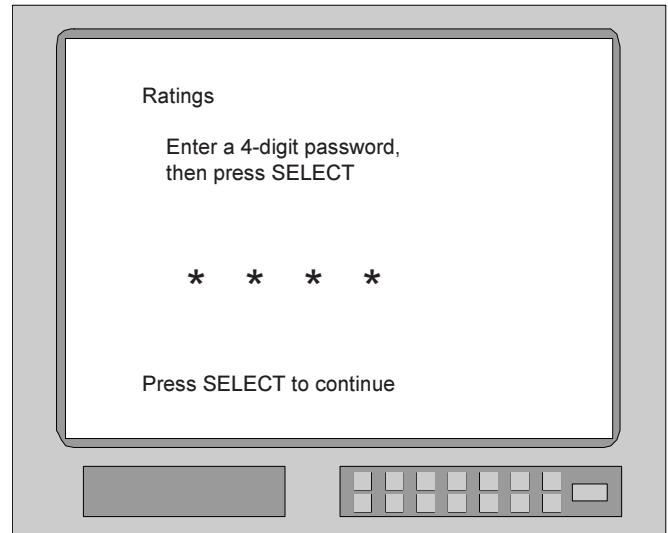

Figure 9

4. Using the Number pushbuttons, enter a 4-digit password number and press SELECT. The player will be locked and will not play discs with Rating Levels at or below the selected rating limit number unless the correct password number is entered.
5. Press SELECT again and the initial setup menu will reappear.

Unlock the Player

1. Press pushbutton Number 2 to access the Ratings Limit Menu. Refer to Figure 3.
2. Enter the previously assigned 4-digit password and then press SELECT. The Ratings Submenu will appear. Refer to Figure 10. The following submenu choices will appear.
 1. Unlock Player
 2. Change Password
 3. Change Level
 4. Temporary Unlock
3. Press 1 and then SELECT to Unlock Player.
4. Press SELECT again and the initial setup menu will reappear.

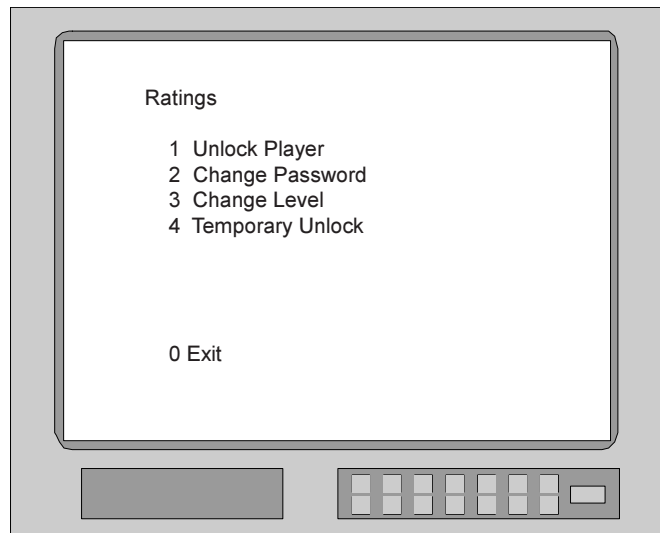

Figure 10

Change Password

1. Press pushbutton Number 2 to access the Ratings menu Refer to Figure 3.
2. Enter the previously assigned 4-digit password and then press SELECT. The Ratings Submenu will appear. Refer to Figure 10.
3. Press 2 to change the password.
4. Enter a new 4-digit Password and press SELECT to activate the change.
5. Press SELECT again and the initial setup menu will reappear.

Change Ratings Level

1. Press pushbutton Number 2 to access the Ratings Menu. Refer to Figure 3.
2. Enter the previously assigned 4-digit password and then press SELECT. The Ratings Submenu will appear. Refer to Figure 10.
3. Press 3 to change (Ratings) Level. Then press the Number for the new desired Ratings level. The initial setup menu will reappear.

Temporarily Unlock

1. Press pushbutton Number 2 to access the Ratings Menu. Refer to Figure 3.
2. Enter the previously assigned 4-digit password and then press SELECT. The Ratings Submenu will appear. Refer to Figure 10.
3. Press 4 to Temporarily Unlock the Player, which is effective only for the current disc in the player.
4. Press SELECT to exit to the initial setup menu.

After all setup adjustments are complete, press pushbutton Number 0 to exit the Initial Setup Menu.

How to Set Menu Language

This allows you to select the language used for the on screen messages such as PLAY, STOP and the Initial Setup Menu.

Note: If a disc is loaded, the player must be in STOP mode before any SETUP operation can occur.

1. Press the SETUP pushbutton to access the Initial Setup Menu. Refer to Figures 3 & 4.
2. Press pushbutton Number 3 to access the On Screen Menu Language screen. English will be indicated as the factory default setting. Refer to Figure 11.
 - Press 1 to select English.
 - Press 2 to select French.
 - Press 3 to select Spanish.

After a selection is made, the initial setup menu will reappear. If all setup adjustments are complete, press pushbutton Number 0 to exit the Initial Setup Menu.

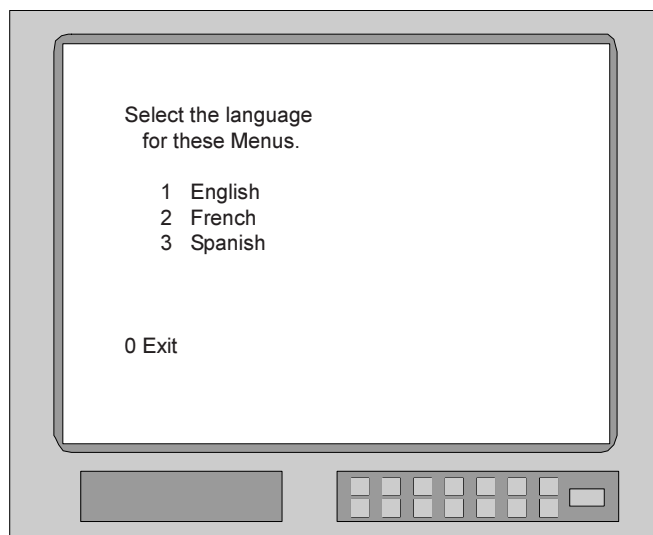

Figure 11

How to Set On-Screen Messages

This allows you to turn On Screen Messages, that appear in the upper right corner of the screen, such as PLAY or STOP On or Off.

Note: If a disc is loaded, the player must be in STOP mode before any SETUP operation can occur.

1. Press the SETUP pushbutton to access the Initial Setup Menu. Refer to Figures 3 & 4.
2. Press pushbutton Number 4 to select the On-Screen Messages Menu. ON will be indicated as the factory default setting. See Figure 12.
 1. Press 1 to select ON.
 2. Press 2 to select OFF.

After a selection is made, the Initial Setup Menu will reappear. If all setup adjustments are complete, press pushbutton Number 0 to exit the Initial Setup Menu.

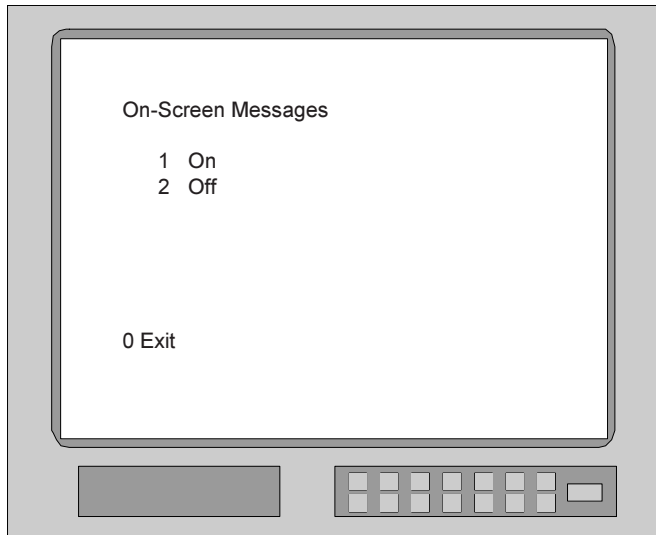

Figure 12

How to Set FL Display

The MVP831 front panel display, just below the disc tray, can be adjusted to be Bright or Dim.

Note: If a disc is loaded, the player must be in STOP mode before any SETUP operation can occur. The other front panel nomenclature is fixed and will not be affected by the Display adjustment operation.

1. Press the SETUP pushbutton to access the initial setup menu.
2. Press pushbutton Number 5 to select the FL Display (Front panel Display Brightness Menu). Bright will be indicated, which is the factory default setting. See Figure 13.
 1. Press 1 to select Bright.
 2. Press 2 to select Dim.

After a selection is made, the initial setup menu will reappear. If all setup adjustments are complete, press pushbutton Number 0 to exit the Initial Setup Menu.

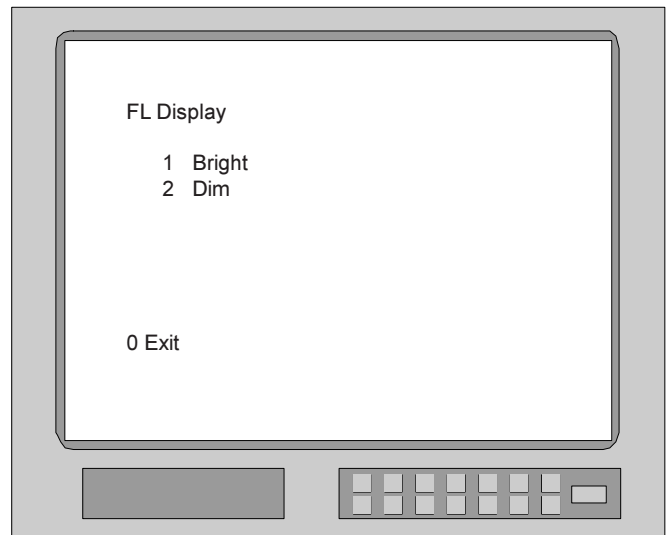

Figure 13

How to Set TV Aspect Ratio

This feature allows you to configure the player to provide the correct video mode to match your Monitor/TV. The width to height screen dimension of a 4:3 Aspect Ratio Monitor/TV match the screen size requirements of videos as well as conventional TV signals. A Monitor/TV with a 16:9 Aspect Ratio will fill its screen with an entire Wide Screen video. Once the TV Aspect Ratio is set, it should not be changed. Make changes only if a Monitor/TV with a different Aspect Ratio is used.

Note: If a disc is loaded, the player must be in STOP mode before any SETUP operation can occur.

1. Press the SETUP pushbutton to access the initial setup menu.
2. Press pushbutton Number 6 to select the TV Aspect Menu. Refer to figure 14.

Note: The 4:3 Aspect will be indicated which is the factory default setting that matches a conventional TV.

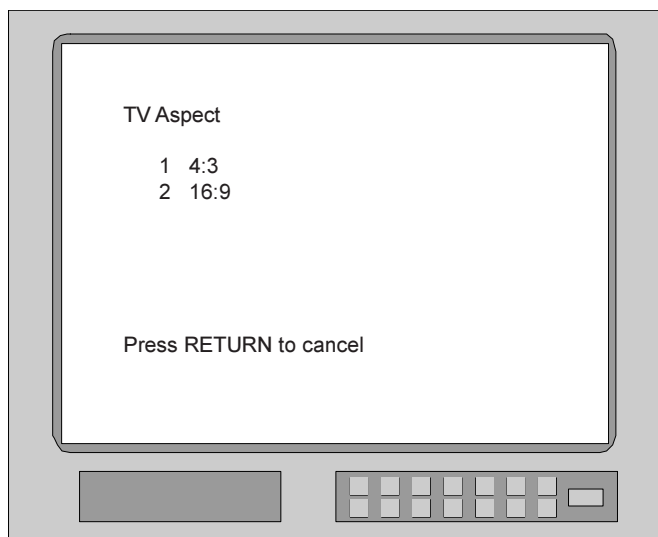

Figure 14

In the 4:3 Aspect mode, if the disc is formatted in the Pan and Scan style, video material at the extreme left and right edges of the original picture will be missing at certain times, even though the entire screen is always full. Refer to Figure 15. If the disc is for-

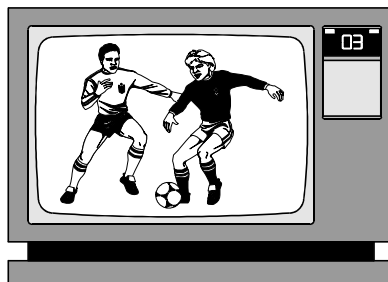

Figure 15

matted in Letterbox, you will see the entire picture but black bands will appear at the top and bottom of the Monitor/TV screen. Refer to Figure 16. 16:9 Aspect matches a wide screen TV or Monitor. The screen will be filled and the entire video picture will be displayed. Refer to Figure 17.

Note: Be certain that the Monitor/TV setup is properly configured for wide screen operation.

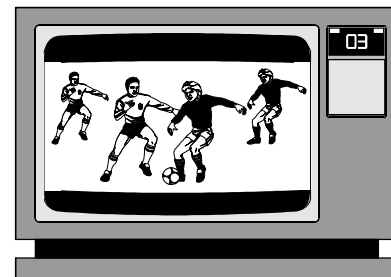

Figure 16

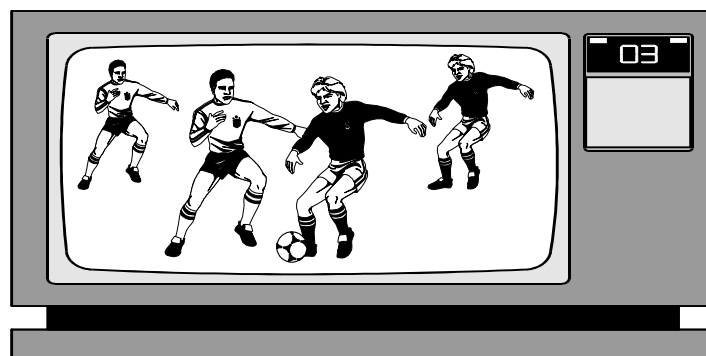

Figure 17

1. Press 1 to select a TV aspect of 4:3.
2. Press 2 to select a TV aspect of 16:9.

After a selection is made, the initial setup menu will reappear. If all setup adjustments are complete, press pushbutton Number 0 to exit the Initial Setup Menu.

How to Set Digital Audio Output

This allows you to configure the MVP831 Digital Audio Output Mode to match the type of A/V Control Center and/or Decoder being used. Follow the recommended Audio Mode Selections that match your A/V Electronics.

Notes: 1. Certain Dolby Digital and dts discs display their own unique Audio Mode Selection menu, every time the disc is loaded into the player. If you do not make a choice from this menu, the disc will revert to its default Audio Mode when play is started. The Audio Mode selected from this menu remains in effect as long as that disc is loaded into the player. If you wish to change the Audio Mode after disc play has started, the disc tray must be opened and closed again, with a new selection made from the menu.

2. If a disc is loaded, the player must be in STOP mode before any SETUP operation can occur.

1. Press the SETUP pushbutton to access the Initial Setup menu.
2. Press pushbutton Number 7 to select the Digital Audio Output Menu. Refer to figure 18.

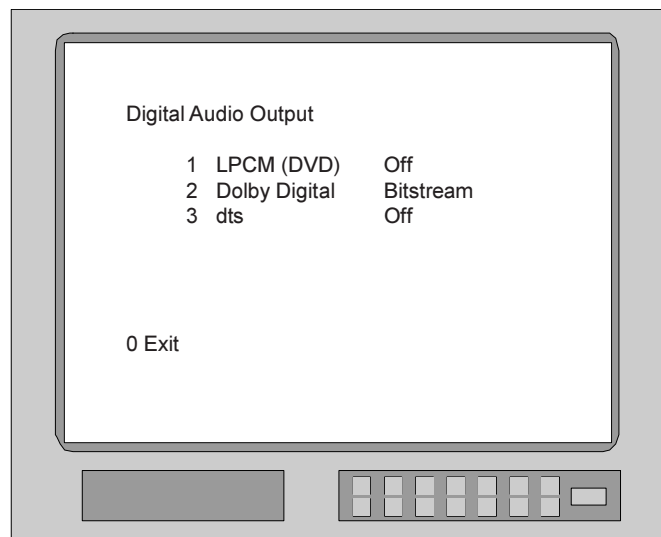

Figure 18

Settings when only Analog Outputs are being used

1. Press pushbutton Number 1 to access LPCM (DVD).
2. Press 1 to select Off.
3. Press pushbutton Number 2 to access Dolby Digital.
4. Press 2 to select PCM.
5. Press pushbutton Number 3 to access dts.
6. Press 1 to select Off.

Settings for A/V Electronics with a 2 Channel Digital to Analog Converter (DAC)

1. Press pushbutton Number 1 to access LPCM (DVD).
2. Press 2 to select PCM.
3. Press pushbutton Number 2 to access Dolby Digital.
4. Press 2 to select PCM.
5. Press pushbutton Number 3 to access dts.
6. Press 1 to select Off.

Settings for A/V Electronics with Dolby Digital Decoder

1. Press pushbutton Number 1 to access LPCM (DVD).
2. Press 2 to select PCM.
3. Press pushbutton Number 2 to access Dolby Digital.
4. Press 1 to select Bitstream.
5. Press pushbutton Number 3 to access dts.
6. Press 1 to select Off.

Settings for A/V Electronics with a dts Decoder

1. Press pushbutton Number 1 to access LPCM (DVD).
2. Press 1 to select Off.
3. Press pushbutton Number 2 to access Dolby Digital.
4. Press 2 to select PCM.
5. Press pushbutton Number 3 to access dts.
6. Press 2 to select Bitstream.

Settings for A/V Electronics with Dolby Digital and dts

1. Press pushbutton Number 1 to access LPCM (DVD).
2. Press 2 to select PCM.
3. Press pushbutton Number 2 to access Dolby Digital.
4. Press 1 to select Bitstream.
5. Press pushbutton Number 3 to access dts.
6. Press 2 to select Bitstream.

After a selection is made, the initial setup menu will reappear. If all setup adjustments are complete, press pushbutton Number 0 to exit the Initial Setup Menu.

How to Set the Other Settings

The Other Settings Menu provides access to four additional operating function options to enhance your enjoyment of the MVP831.

Note: If a disc is loaded, the player must be in STOP mode before any SETUP operation can occur.

1. Press the SETUP pushbutton to access the Initial Setup menu. Refer to figure 19.
2. Press pushbutton Number 9 to access the Other Settings menu and the following four Submenu choices will appear.

1. Still Mode
2. Audio during Search
3. TV Mode (4:3)
4. D Range Compression

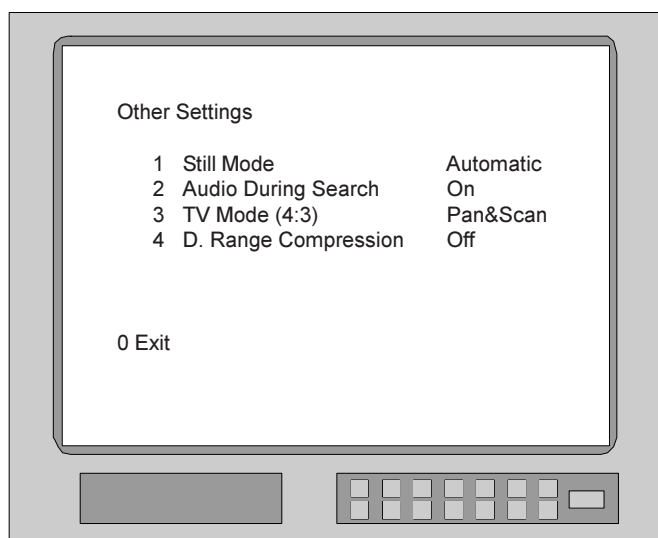

Figure 19

Still Mode

The Default Still Mode setting of Automatic should normally be satisfactory when viewing a single video frame at a time. If you encounter video picture jittering with certain discs, select Field instead of Automatic to correct the problem.

Press pushbutton Number 1 and the following two Submenu choices will appear.

1. Automatic (Factory Default setting)
2. Field

Press pushbutton Number 1 to select Automatic. Press 2 to select the Field. Use when jittering occurs in the pictures.

After a selection is made, the Other Settings Menu will reappear. If all setup adjustments are complete, press pushbutton Number 0 to exit to the Initial Setup Menu. Press 0 again to exit the Initial Setup Menu.

Audio During Search

This allows you to hear audio during FF (Fast Forward) and REV (Reverse) operation while playing a CD/DVD.

Press pushbutton Number 2 and the following two submenu choices will appear.

1. On
2. Off

Press 1 to select On. Audio will be heard during FF and REV.

Press 2 to select Off.

After a selection is made, the Other Settings Menu will reappear. If all setup adjustments are complete, press pushbutton Number 0 to exit to the Initial Setup Menu. Press 0 again to exit the Initial Setup Menu.

TV Mode (4:3)

The TV Mode (4:3) Feature is used only with a conventional TV. 4:3 refers to the horizontal to vertical screen size ratio. TV Mode (4:3) allows you to select the video format of your choice on certain DVD's that are single sided with two layers and have no Format Selection Menu. One layer will contain the Video in Pan and Scan Format, and the



Figure 20

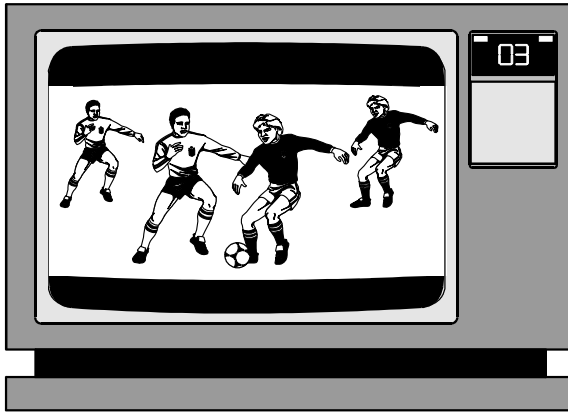

Figure 21

other layer in Letterbox Format. Refer to figure 20 (Pan&Scan) and figure 21 (Letterbox).

Some two layer discs display their own unique Video Format Selection Menu, every time the disc is loaded into the player. If you do not make a choice from this menu, the disc will revert to its default Video Format when play is started. The Format selected from this menu remains in effect as long as that disc is loaded into the player. If you wish to change the Video Format after disc play has started, the disc tray must be opened and closed again, with a new selection made from the menu. If a disc is loaded, the player must be in STOP mode before any SETUP operation can occur. If the two layer disc does not have a Format Menu, follow the instructions below to select the desired video format for your TV.

Press pushbutton Number 3 and the following two submenu choices will appear.

1. Pan and Scan
2. Letterbox

Press 1 to select Pan and Scan.

Press 2 to select Letterbox.

After a selection is made, the Other Settings Menu will reappear. If all setup adjustments are complete, press pushbutton Number 0 to exit to the Initial Setup Menu. Press 0 again to exit the Initial Setup Menu.

D. Range Compression

With certain selected DVDs the Dolby Digital Sound Tracks include an encoded signal that can reduce the dynamic range of the audio signals. The loudest passages are reduced in volume, while the softer passages are increased so they are still audible. This feature is useful for late night listening so others aren't disturbed.

Press pushbutton Number 4 to access the Range Compression Submenu.

Press 1 to turn Dynamic Range Compression Off.

Press 2 to turn Dynamic Range Compression On.

After a selection is made the Other Settings Menu will reappear.

Press "0" to return to the Initial Settings Menu. After a selection is made, the Initial Setup Menu will reappear. If all setup adjustments are complete, press pushbutton Number 0 to exit the Initial Setup Menu.

How to Operate the MVP831

Your McIntosh MVP831 has been configured for default operating settings that will allow you to immediately enjoy superb video and high fidelity audio from a DVD or CD disc. If you wish to make changes to the default settings, a Setup feature is provided to customize the operating settings using On Screen Menus (refer to the Setup instructions elsewhere in this manual.) Most operations that can be performed with the front panel pushbuttons can also be performed with the remote control.

Note: Some of the MVP831 operating functions such as Disc Languages, Video Angle or Menu Language are active only if the function is supported by data encoded on the disc.

Power On

Press the POWER switch to ON. The Red LED above the STANDBY/ON switch lights to indicate the MVP831 is in Standby Mode. To turn ON the MVP831, press the STANDBY/ON On push-button. Refer to figure 22.

Note: When a Power Control cable is connected to a McIntosh Control Center, the MVP831 Power Switch can be left ON, and the player will turn on automatically whenever the other component turns on.

Reset of Microprocessors

In the event that the controls of the MVP831 stop functioning, turn the POWER switch off for 5 seconds, then back on. This will reset the MVP831 microprocessors.

How to Load and play a DVD/CD Disc

1. Press the OPEN/CLOSE pushbutton. The disc tray will slide out allowing a disc to be loaded. Refer to figure 22.
2. Press the PLAY pushbutton. The disc tray will close and the disc will start to play from the beginning.

- Note: 1. One optional method to start a loaded DVD disc playing is to press the OPEN/CLOSE pushbutton a second time. The disc tray will close and the DVD disc will start to play. You must always press PLAY after a CD has been loaded. It will not start automatically.*
- 2. When the player is in Standby Mode, the power will automatically turn on when the OPEN/CLOSE pushbutton is pressed and the disc tray will open. If a DVD/CD disc is loaded and the player is in Standby mode, press the PLAY pushbutton to turn power on and start the disc playing. Certain DVDs will require you to make an initial selection of Screen Format as well as Sound Format. These selections will override any similar selections made with the MVP831 Setup Menus.*

Resume Play Mode

The MVP831 has a built-in Play/Resume feature. This allows you to stop playing a disc at any time, and resume listening/viewing where you left off when play was stopped.

1. To activate Resume/Play, press STOP once. The disc time at that instant will be memorized.
2. Press PLAY again and it will resume playing from the time where you had previously stopped playing.
3. If the player is put in Standby Mode by pressing the Standby/On pushbutton, Play/Resume memory will be retained. Press PLAY again and the player will turn on and resume play at the time you left off.

Note: If the disc tray is opened, the MVP831 Front Panel Power Switch is turned off, or the power cord is unplugged, the Resume Play memory will be erased.

DVD Disc Pause/Still Frame

This feature allows you to pause during disc play. You can also cycle forward or backward through a disc, one video

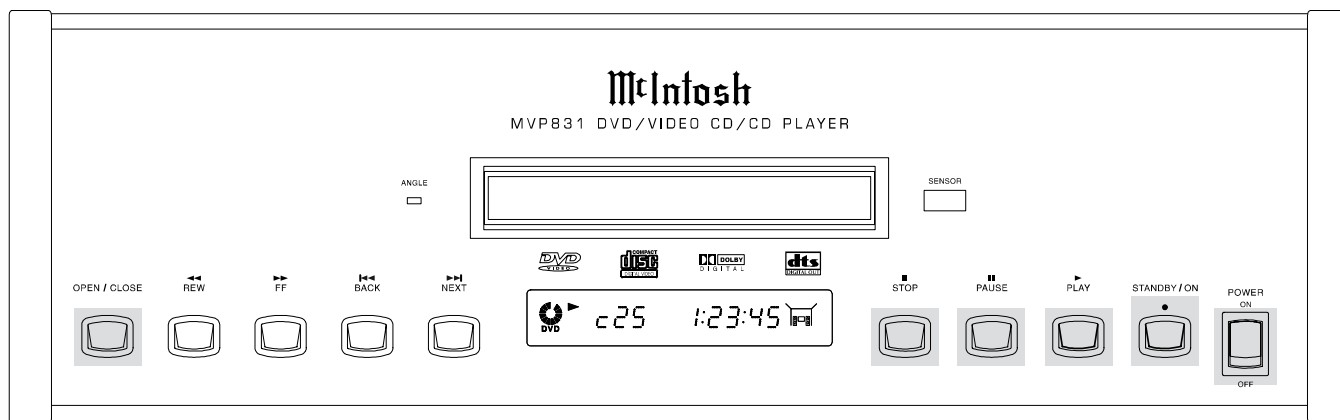

Figure 22

picture frame at a time, and at different speeds.

1. When playing a DVD Disc, press the PAUSE pushbutton to temporarily stop play. After PAUSE has been activated, each additional time you press PAUSE the disc will advance one video frame at a time.

Note: In this mode, press either the FF or REV pushbuttons to move more rapidly forward or backward a frame at a time on a DVD.

2. Press the PLAY pushbutton to cancel Pause and resume playing a DVD.

CD Disc Pause

When playing a CD Disc, press PAUSE to temporarily stop play. Press the PLAY pushbutton to cancel Pause and resume playing.

DVD/CD Disc REV and FF

This feature allows rapid backward or forward (REV or FF) disc play. You have the Setup option of turning audio on or off audio during the fast play operation.

1. Press a REV (Reverse) or FF (Fast Forward) pushbutton to move rapidly backward or forward through a disc. Press the same pushbutton again up to three times, and the search speed will increase successively. An Icon will appear indicating the direction and speed of the fast operation.
2. Cancel the REV or FF mode by pressing the Play pushbutton and normal play will resume.

On Screen Icon Display

Three sets of On Screen Icons are available to inform you of current operating conditions and allow activation of temporary operating changes for a disc currently being played. Press the DISPLAY pushbutton once to access the first set of On Screen Icons. Press DISPLAY a second and third time to access the second and third sets of icons. Press DISPLAY a fourth time to remove the icons from the screen. If a selection is made with an Icon, the display will disappear. Certain On Screen Icon operations are accessed

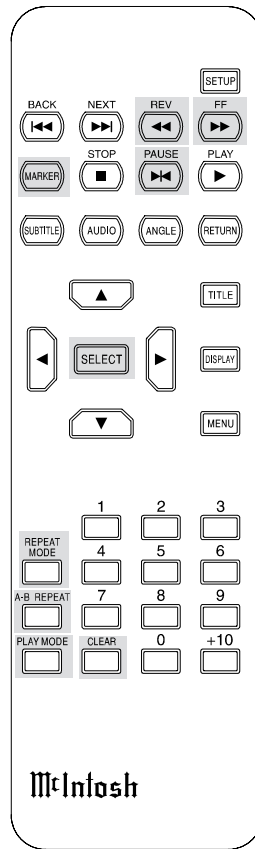

Figure 23

with Remote Control pushbuttons, and only the selected Icon will appear. Refer to figures 23, 24, 25 & 26.



Figure 24



Figure 25



Figure 26

Direct DVD Disc Chapter Selection

The MVP831 front panel display indicates the Disc Chapter currently playing. An On Screen Icon also indicates the DVD Chapter Number currently being played, with the ability to select a different Chapter. Refer to Figure 24.

1. Press the DISPLAY pushbutton to access the first group of DVD On Screen Icons.
2. Press an ARROW pushbutton to access the second Icon from the left (C), which indicates the Chapter Number currently playing.
3. To access a different Chapter, press a Numbered pushbutton(s) and then SELECT.

Direct CD Track Selection

Selecting a different track on a CD requires only a Number pushbutton to be pressed. A different Track can be selected during play. In the STOP Mode, select a Track Number and then Press PLAY to start playing the disc with the selected track. The CD track number and elapsed time will also appear on the MVP831 Front Panel Display. Refer to figure 23 and 24.

1. Press a Number pushbutton for the CD track you wish to play.
2. To display the track number currently being played, press DISPLAY to access the first group of On Screen Icons for CD.
3. The first Icon on the left (T) will indicate the current track being played and the second Icon will indicate the elapsed time.
4. To access a track using the On Screen Icon, press a Numbered pushbutton(s) to access a different track and then press SELECT.

How to Operate the MVP831, con't

Access a Specific Time location on a DVD

You can start a DVD playing at any time in the disc by using the Elapsed Play Time feature. Refer to figure 24.

1. Press the DISPLAY pushbutton to access the first group of DVD On Screen Icons. The third Icon from the left will indicate the elapsed time of the disc as it is playing.
2. Press a Right ARROW pushbutton to access the Elapsed Time Icon. The elapsed time readings will disappear to allow a new time to be entered.
3. Press a Numbered pushbutton(s) to enter a time point and then SELECT. The DVD will immediately start playing at the chosen time in the disc.

CD Disc Play Mode

This feature allows you to choose which tracks of a CD that you wish to play. You can also choose Random Play of Disc tracks. An On Screen Display will indicate the total number of tracks and the specific tracks you have selected. Refer to figure 27.

Note: The Player must be in STOP Mode to activate the Play Mode feature.

1. In the STOP mode, press the PLAY MODE pushbutton to access the CD/CD-Video On Screen Program Menu. The available disc tracks will appear on the left side of the screen.
2. Use the ARROW pushbuttons to move to the specific track that you wish to play and press the SELECT pushbutton. The selected track number will appear in the right hand column. Up to 18 tracks can be stored in memory for selective play.

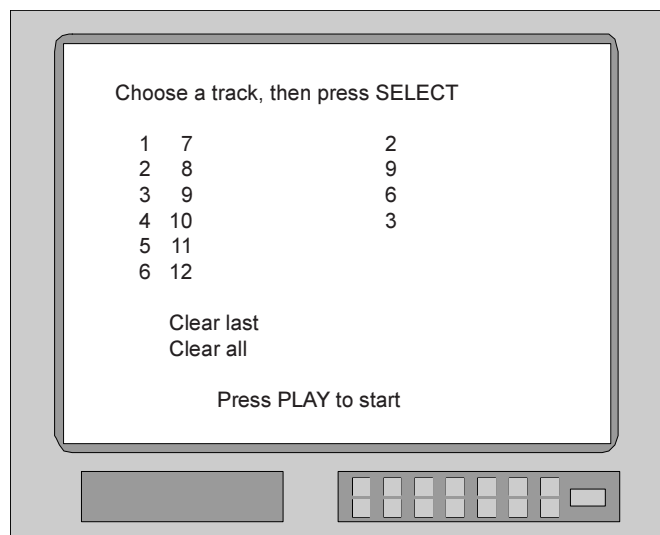

Figure 27

3. Use the Down ARROW pushbutton to access Clear the Last Selection or Clear All Selections and press SELECT to activate.
4. Press the PLAY MODE pushbutton twice to select the option of Random Play of all tracks on the disc.
5. Cancel the Play Mode by pressing the PLAY MODE pushbutton three times.

How to Set Markers

This feature allows you establish up to four different times on a disc where you wish play to start, other than at the beginning of the disc. Refer to figure 25.

1. Press the DISPLAY pushbutton twice and an ARROW pushbutton to access the MARKER On Screen Icon.
2. While a disc is playing, press the MARKER pushbutton at the time on the disc where you wish play to start, other than at the beginning of the Disc. The MARKER Icon will appear on the screen
3. Press the SELECT pushbutton to place marker No. 1 in memory.
4. Press the Right ARROW pushbutton to advance to MARKER Number 2 on the Icon display. At the time on the disc where you wish to create a second starting point, press the SELECT pushbutton again to select a second play point. Up to five markers can be stored in memory. The On Screen Marker Icon Display will indicate the total number of Markers that have been stored in memory.
5. To start play at a Marker Icon Number, first press PLAY and then MARKER. With the left or right ARROW pushbutton move to the Marker Icon number where you wish play to start. Press the UP ARROW pushbutton and the disc will immediately start to play at that marker point.

Note: If you wish to erase a MARKER, move to the desired Marker Icon Number with an ARROW key and press the CLEAR pushbutton.



Figure 25

DVD Repeat Mode

This allows you to repeat a DVD Chapter or the entire disc on a continuous basis.

1. Press the REPEAT MODE pushbutton once during disc play to repeat a DVD chapter. The On Screen Icon will appear with C indicated.

2. Press REPEAT MODE a second time to repeat an entire disc. The Icon will indicate T.
3. Press REPEAT MODE a third time to cancel the Repeat mode. The Icon will indicate Off.

CD Repeat Mode

1. Press the REPEAT MODE pushbutton once during disc play to access the Repeat Icon. The On Screen Icon will appear with Off indicated. Refer to figure 25.
2. Press REPEAT MODE a second time to repeat a single track. The Icon will indicate T.
3. Press REPEAT MODE a third time to repeat the entire disc. The Icon will indicate A (All Tracks).
4. Press REPEAT MODE a fourth time to cancel the Repeat mode. The Icon will indicate Off.

DVD and CD Disc A-B Repeat

1. While a disc is playing, press the Remote Control A-B REPEAT pushbutton to store in memory the time on a disc where you wish to start a segment for repeat play. The A-B Repeat On Screen Icon will appear with A displayed. Refer to figure 25.
2. Press A-B REPEAT a second time when you reach the time on the disc where the repeatable segment is to end. The On Screen Icon will now display A and B. The selected disc segment will start to play repeatedly.
3. Cancel the A-B REPEAT mode by pressing the A-B REPEAT pushbutton a third time.

To View or Change DVD Disc Language

Many DVD's are encoded with more than one audio Sound Track Language. You have the ability to select your preferred language. Refer to figure 24.

1. Press DISPLAY once to access the first group of On Screen Icons. The fourth Icon from the left indicates the current disc sound track language in use.
2. Press an Up or Down pushbutton to access the sound track audio language you prefer.

Notes: 1. If the selected language fails to access, it is not encoded on the disc. If the language selected by the Icon is different from the Language selected in Initial Setup, the player will revert to the initial setup language if the disc is removed or the power turned off.

2. The disc language Icon can also be directly accessed by pressing the AUDIO pushbutton.



Figure 24

To Add, Remove or Change Subtitle Language

Most discs include subtitle capability to match the available disc languages. You have the ability to choose the preferred subtitle language and turn the Subtitle feature On or Off.

1. Press the SUBTITLE Pushbutton and the Subtitle Icon will appear. The current Subtitle language and whether it is turned on or off will be indicated.
2. Press an Up or Down ARROW pushbutton to scroll through the available Subtitle languages. When the preferred language is displayed, it will automatically be selected.
3. Press a Left or Right Left ARROW pushbutton to turn the Subtitle feature On or Off.

Note: To turn the Subtitle feature On or Off, you must access the Icon with the Subtitle pushbutton.

How to Select a Video Angle Preference

Certain DVD's are encoded with more than one video picture viewing angle. You have the ability to choose the video angle you prefer. The front panel ANGLE Indicator will light to indicate that the disc being played has a multiple angle feature. Refer to figure 24.

1. Press the ANGLE pushbutton. The ANGLE Icon will appear indicating the current Angle, No. 1, in use.
2. Press a Number pushbutton to select a different angle. If no change occurs when a Number is entered, this indicates that the disc has only a single video angle encoded.

DVD Title Selection

Titles can refer to movie trailers, menus or different disc formats. If a different format is chosen with this icon, it will be effective as long as the disc is playing. If Play is stopped, the format will revert to the original settings. Refer to figure 24.

1. Press the DISPLAY pushbutton to access the first group of DVD On Screen Icons.
2. The first Icon on the left (T) indicates the DVD Title Number.
3. To access a different Title, press a Number pushbutton and then SELECT.

Video Specifications

Signal System

NTSC

S-Video Y Output Level

1Vp-p (75 OHM)

S-Video C Output Level

0.286Vp-p (75 OHM) (NTSC)

Video Output Level

1Vp-p (75 OHM)

Audio Specifications

Number of Channels

2

Output level

2.2Vrms

DVD Frequency Response

4-22KHz (48KHz Sampling, Linear Audio)

4-44KHz (96KHz Sampling, Linear Audio)

CD Frequency Response

4-20KHz

CD Signal to Noise Ratio

Better than 110dB (A-weighted)

DVD Dynamic Range

Better than 100dB (Linear Audio)

CD Dynamic Range

Better than 98dB

Harmonic Distortion

0.003% (1KHz)

Channel Separation

Better than 110dB (1KHz)

General Specifications

Digital Output

Optical: -15dbm to -21dbm

Coaxial: 0.5V p-p/75 ohm

Digital Signal Format

Sampling Frequency: 44.1kHz & 48kHz

Transport

Laser Beam Wavelength: 655nm

Laser Power CLASS II

Power Requirements

100 Volts, 50/60Hz at 28 watts

110 Volts, 50/60Hz at 28 watts

120 Volts, 50/60Hz at 28 watts

220 Volts, 50/60Hz at 28 watts

230 Volts, 50/60Hz at 28 watts

240 Volts, 50/60Hz at 28 watts

Note: Refer to the rear panel of the MVP831 for the correct voltage.

Dimensions

Front Panel: 17-1/2 inches (44.5cm) wide, 5-3/8 inches (13.7cm) high, depth behind front mounting panel is 15 inches (38.1cm) including clearance for connectors. Panel clearance required in front of mounting panel is 3/4 inch (1.9cm).

Note: When the DVD/CD tray is opened, the panel clearance required in front of mounting panel is 6-3/4 inches (17.2cm).

Weight

20 pounds (9.0Kg) net, 34 pounds (15.4Kg) in shipping carton

Packing Instructions

In the event it is necessary to repack the equipment for shipment, the equipment must be packed exactly as shown below. It is very important that the four plastic feet are attached to the bottom of the equipment. This will ensure the proper equipment location on the bottom pad. Failure to do this will result in shipping damage.

Use the original shipping carton and interior parts only if they are all in good serviceable condition. If a shipping carton or any of the interior part(s) are needed, please call or write Customer Service Department of McIntosh Laboratory. Please see the Part List for the correct part numbers.

Quantity	Part Number	Description
1	034075	Shipping carton only
4	033837	Foam end cap
1	034076	Inside carton only
1	033726	Top pad
1	034036	Bottom pad
1	034077	Inner carton pad
4	017218	Plastic foot
4	100159	#10-32 x 3/4" screw
4	104083	#10 x 7/16" Flat washer
1	049270	Shipping carton complete with all the above parts

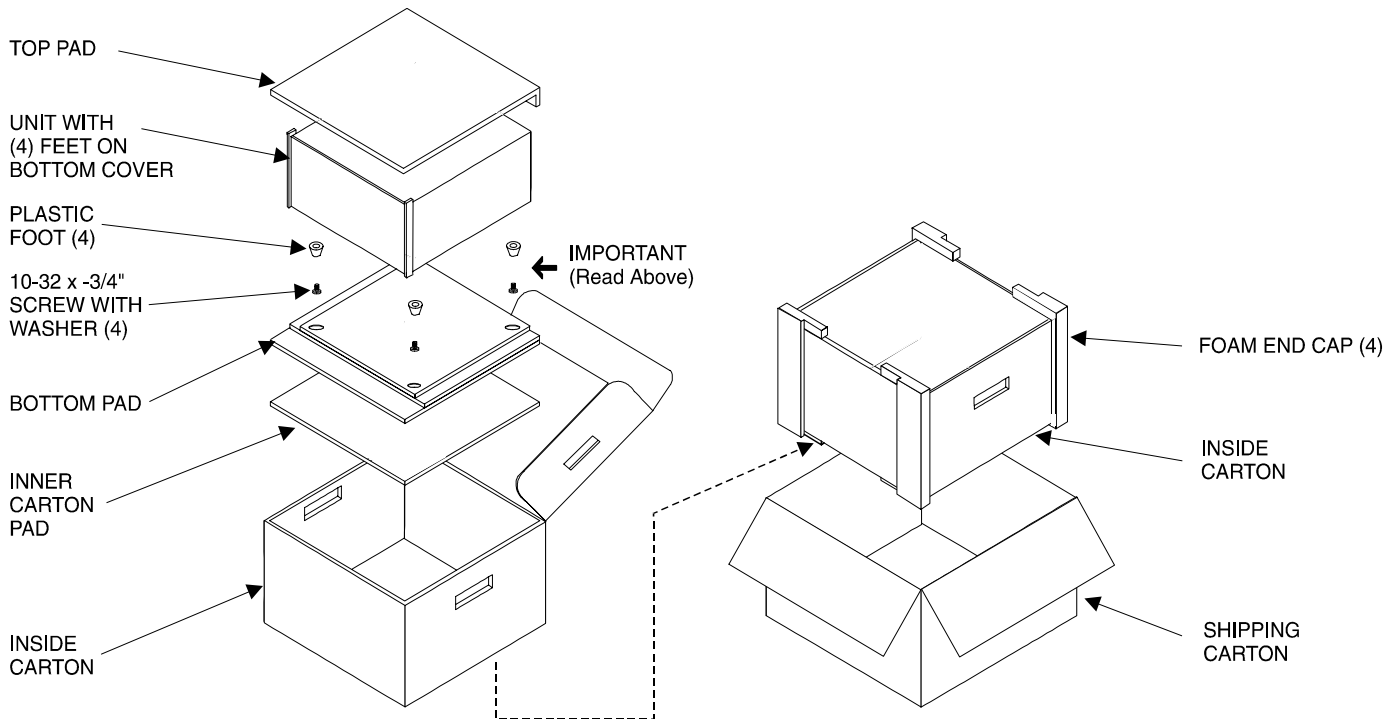

McIntosh[®]

McIntosh Laboratory, Inc.
2 Chambers Street
Binghamton, NY 13903